

ENGINEERING CONSULTANCY SERVICES

EXCELLENCE IN VALUE ENGINEERING



VISION

To Provide Quality Design and Engineering Consultancy Service.



MISSION

Customer Satisfaction through Professional Service.



STRATEGY

Exhibit Excellence in Value Engineering.

Who We Are

Voltech Group, started in the year 1995, located in Chennai, India, is a well-established state of the art Global Engineering Company in Electrical and Electronics industry with 29 years of rich global domain experience,

We are the manufacturers of Transformers, MV switchgears, Relays, Control & Relay panels, Battery Chargers, Flame proof products, Solar PV Panels and Testing & Commissioning service providers with 5000+ engineering professionals around the globe. We are now present in about 50 countries across all continents.

The Design and Engineering Consultancy Division of Voltech is an ISO 9001 – 2015 certified Design House, which provides one stop, end to end design and engineering consultancy services to various EPC customers, Industry owners and utilities in the field of Electrical, Instrumentation, Civil and Structural engineering under one roof.. It is one of the lead engineering and consultancy firm in the field of Power Generation, Transmission, Distribution, Renewables, Oil & Gas , Steel, Cement and other various industries,.



MD's Message

Greetings from Voltech !!!

We, Voltech Engineers Pvt. Ltd. an ISO 9001:2015 certified company, are engaged in rendering services and manufactured products of electrical electronics engineering. We have gained vast experience in the field related to Transmission and Distribution, Power Generation, all types of Industries and other Utilities by way of Engineering, Manufacturing, Testing & Commissioning and Operation & Maintenance.

Our state of the art, ISO 9001-2015 certified, Design and Engineering Consultancy Division is an independent business vertical within the Voltech Group, headed by **Mr. S. Angelson Rajeshkumar**, an electrical design engineer by profession, with 25 years of industry experience. Having gained rich global experience, we are well poised to provide design and engineering consultancy services to all the industry segments.

I am sure that this profile will provide sufficient information about our services and we look forward to receiving your valuable enquiries for providing our Consultancy services in Design and Engineering.

With Regards,



M. Umapathi B.E., F.I.E.,
Chairman & Managing Director
Voltech Group of Companies



Our Services

Substation Engineering

We undertake complete Design Consultancy services for AIS & GIS, EHV substations upto 765kV. We act either as Project Developer's consultants, Owners or EPC contractor's consultants.

Our gamut of services covers Electrical primary and secondary engineering, Civil & Structural engineering and HVAC & Firefighting engineering which includes Technical Specification preparation, Design & Detailing, Procurement support, Equipment Vendor drawing reviews and FAT services.

We support EPC contractors during prebid stage providing Specification Review, Cost competitive Layout engineering, Optimum BoQs, Value engineering advice and Vendor selection

Transmission Line Engineering

Civil & Structural engineering services includes substations and transmission lines.

Our Transmission line engineering services can range from Surveys to commissioning upto 400kV. The services include site survey, Transmission Line services, Tower spotting, Tower design and detailing, Tower foundation engineering, Procurement support, Vendor drawings reviews and FAT services

Our Substation engineering covers, Soil investigation review, foundation engineering, Structural design & detailing, Building engineering, and MEP services

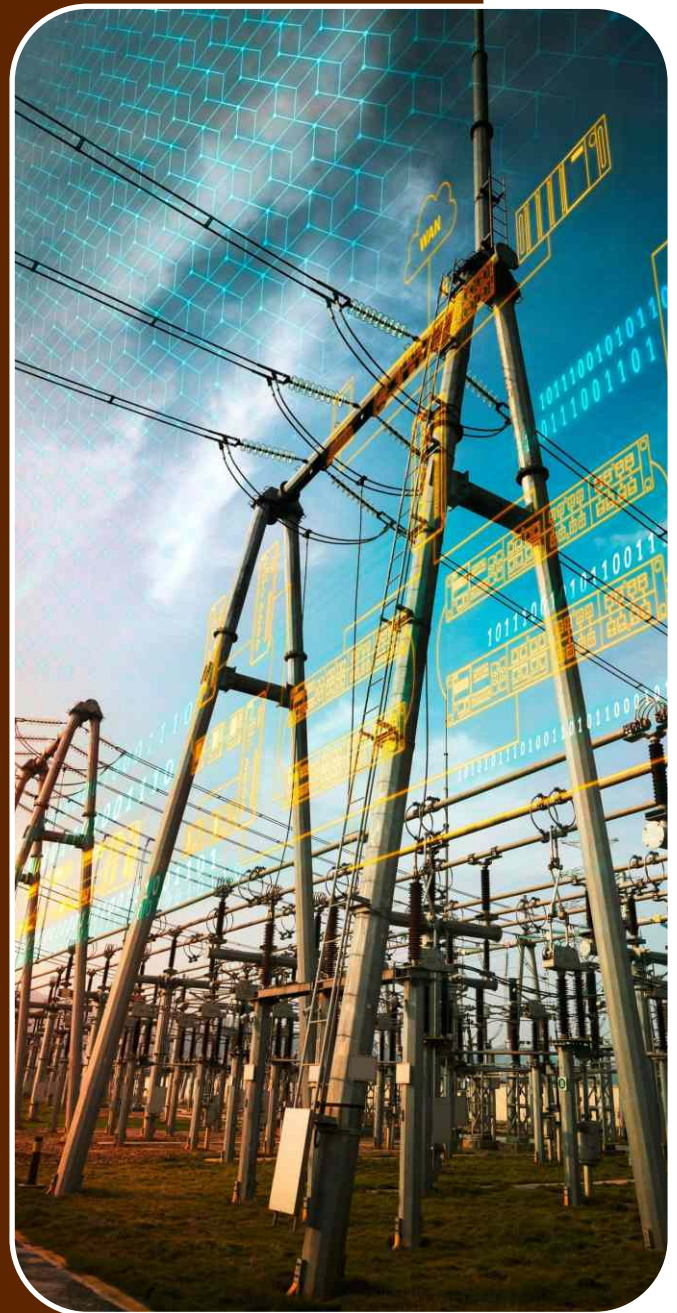

Renewables Engineering

We also offer consultancy services from concept to commissioning of Roof top/ Ground Mount Solar Plants from kW range to Multi Megawatt range, involving Solar Shading Analysis, Power generation studies and preparation of detailed drawings like, array layout, Plot plan, SLD, BoM structural drawings, discom documentations, procurement support & FAT services.

Designing and Engineering of installation of Wind Power Plant and associated works such as evacuation system (lines & substation) from wind power generator up to utility point.

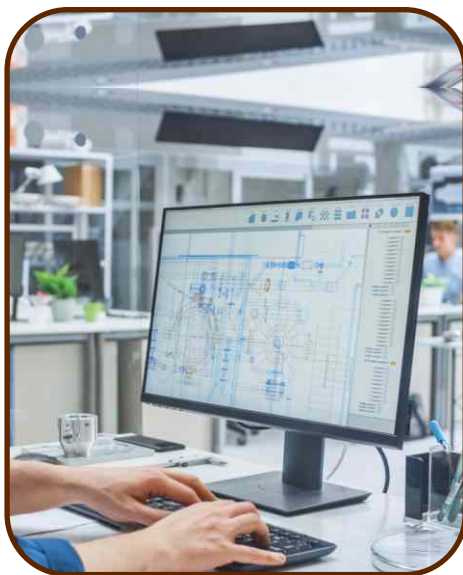
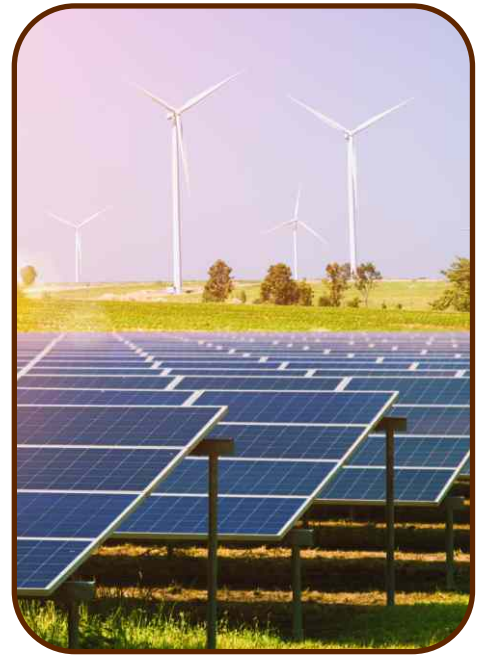

Power System Studies

We are pioneers in providing various Power System Studies like, Load Flow, Short Circuit Calculation, Relay Co-ordination and Settings, Arc Flash Studies and Harmonic Studies for various industrial plants

We provide transient studies like, Insulation co-ordination, Ferro resonance studies, Transient stability studies Fast bus transfer analysis and Transformer energization. We are experts in network and modelling using ETAP & EMTP softwares.

Industrial Plant Engineering

We provide Electrical & Instrumentation consultancy services for various industries like, Cement Plants, Water treatment Plants, Power Plants, Steel Plants, Paper Plants, Automobile Plants, Petrochemical Plants and so on.

Our capabilities span from Technical specification preparation, System studies, Equipment sizing calculations, Earthing, Lightning Protection & Cabling, detail engineering and Procurement support to FAT services.



Substation Engineering: AIS & GIS

Pre Bid Engineering | Post Bid Engineering | Site Visit Support

CIVIL & STRUCTURAL

- Site investigations
- Tower/Equipment Support Structure
- Control Building /GIS Buildings
- Tower/Equipment Foundations
- Cable Trench
- Roads & Drains
- Fence/Boundary Wall

ELECTRICAL

- Technical Specification
- Design Basis Report
- Conductor Sizing
- SCF & SAG Calculation
- Key SLD /PSLD
- Layout Engineering
- Earthing & Lightning Protection
- Control & Protection
- Cabling Systems
- Aux System (AC/DC) Design
- Procurement Support
- Installation & Commissioning Support
- Vendor Equipment Engineering
- Equipment Inspections (FAT)

OUR ACHIEVEMENTS

- 765kV SS - 5 Projects.
- 500/400kV - 20 Projects.
- 220kV & below - 100+ Projects.
- Domestic Projects - 150+
- International Projects - 30+
- AIS - 150 Projects.
- GIS - 50 Projects.

DOMAIN

- Utility Substations
- Renewable Substations
- Industry Substations
- Distribution Substations



Our Major Projects

Project ID	Project	Scope	Client	End Client	Year of Execution
INTERNATIONAL PROJECTS					
DP23098	132kV Power Output Substation Nupche Likhu HEP (3x19.17MW), Nepal	Electrical and Civil Engineering	Voith, India	Vision Energy & Power Public Ltd. Nepal	2023
DP21062	Establishment 16 of AIS Substations in Development of the electricity transmission network, Tunisia	Electrical Engineering	Kalpataru Power Transmission Ltd, India	Tunisian Electricity and Gas Co. (STEG)	2021
DP584	Electrical and Civil Engineering at 138/90kV AIS substation at Nicaragua, Central America	Electrical and Civil Engineering	Transrail Lighting, India	ENATREL, Nicaragua	2020
CP551	Construction of two 225KV Single Circuit Transmission Line from Nkongsamba Bafoussam, Abong Mbang-Yaounde and Associated Facilities, Cameroon	Electrical and Civil Engineering	Kalpataru Power Transmission Ltd, India	Ministry of Water Resources & Energy Republic Of Cameroon	2019
DOMESTIC PROJECTS					
DP25019	Construction of switchyard at 2X800MW (PH-II) Mahan ultra super critical Thermal Power at Sigravli, Madhya Pradesh, India	Electrical and Civil Engineering	Godrej & Boyce MFG.CO.LTD., India	Adani Mahan Energen Ltd	2024
DP25017	220kV Pooling Substation associated with 300MW Solar PV Power Project, Nokha Dahiya, Rajasthan, India	Owner's Engineer Service	ACME Solar Holdings Pvt. Ltd., India	ACME Sikar Holdings Pvt. Ltd.	2024
DP24091	110kV Pooling Substation associated ESP05, 50MW Solar PV Plant at Yadgir, Karnataka, India	Electrical and Civil Engineering	Enerparc Solar Power Pvt. Ltd., India	Bagmane Developers Pvt. Ltd.	2024
DP24015	Establishment 2X500 MVA, 400/220 kV GIS Substation at Dommasandra in Bengaluru , India	Electrical and Civil Engineering	Kalpataru Power Transmission Ltd., India	KPTCL	2023
DP23100	220/33kV GIS S/S for Data Center at Hyderabad, India	Electrical Engineering	Siemens, India	Adani Connex, India	2022
DP22007	Electrical and Civil Engineering for 400kV GIS extension of 765/400kV GIS Substation at Aligarh, UP, India.	Electrical and Civil Engineering	Hyosung T & D India Pvt Ltd.	Power grid corporation of India Ltd.	2021
CP427	220/132/33kV Grid Substation At Samastipur, Bihar.	Electrical Engineering	Bajaj Electricals, India	Bihar State Power Transmission Company Ltd.	2018
CP346	400KV/11KV Tukkapur Substaion in Siddipet Dist. Under Kaleshwaram Lift Irrigation Scheme (Package-12), Telangana, India	Electrical Engineering	Siemens, India	Transmission Corporation Of Telangana Ltd.	2017
CP321	765/400KV Parli, Warora AIS Substation, Maharashtra	Electrical Engineering	Siemens, India	Powergrid Parli Transmission	2016
CP219	230KV AIS SS At Vyasarpadi In Chennai Region	Electrical Engineering	Alstom T&D India Ltd.	Tamilnadu Transmission Corporation Ltd	2014
CP193	Alstom Trn Energy 400KV Extn. SS At Raigarh	Electrical Engineering	Trn Energy Ltd.	Power Grid Corporation Of India Ltd.	2013

* For detailed Project list, Kindly Contact Us

Transmission Line Engineering

TRANSMISSION LINE ENGINEERING



- Site Survey Support
- Design Basis and Specification
- Sag Tension Calculations, Tower Spotting and Profile preparation
- Wind load calculations
- Tower Design in STAAD pro / PLS Tower
- Tower Fabrication and Shop drawings
- Tower Foundation Design
- Complete BoM of Electrical, Civil & Structural
- Sag Tension Stringing Chart
- Type test support

OUR TESTED TRANSMISSION LINE PROJECT

Voltech designed the towers of the 132kV, DC transmission line for power evacuation from Likhu-1, 2 & A HEP to New Khimti of Numbur Himalaya Hydropower. The EPC contractor is Apollo Ltd, New Delhi. The designed DCS type tower was tested successfully at Transrail Testing Facility at Wardha, Maharashtra, India



Transrail Testing Centre TRANSRAIL
FORWARD HO PROGRESS

TOWER TEST REPORT (Sample Number: 191/Nov/2021)

W.D. No.	Type of Tower	Specification No.	Test Report No.
GT48	DCS BTB +9m B.E. +3m L.E.		316/2020-21

Report on the Design Test carried out on a Black Proto Type "DCS" BTB +9m B.E. +3m L.E. For 132 kV DC Transmission Line For Power Evacuation From Likhu-1, LIKHU2 & LIKHU A HEP to New Khimti PROJECT
132 kV DC TRANSMISSION LINE FOR POWER EVACUATION FROM LIKHU-1, LIKHU2 & LIKHU A HEP TO NEW KHIMTI

END USER / PURCHASER: NUMBUR HIMALAYA HYDROPOWER PVT. LTD. (NHHP) NEPAL
CONTRACTOR: APOLLO INTERNATIONAL LTD. GURGAON INDIA.
DESIGNER: VOLTECH ENGINEERS PVT.LTD
DESIGNER REVIEWER: ENERGY INFRATECH PVT.LTD
MANUFACTURER: MAN STRUCTURALS PVT. LTD.
TOWER TESTED BY: TRANSRAIL TESTING CENTRE (TTC)
CUSTOMER OF TTC: TRANSRAIL LIGHTING LIMITED, MUMBAI
PLACE OF TESTING: TRANSRAIL TESTING CENTRE, DEOLI, WARDHA
DURATION OF TESTING: 20th TO 23rd FEBRUARY 2020

TESTING WITNESSED BY	
Mr. Mohan Neupane	Numbur Himalaya Hydropower Pvt. Ltd. Nepal
Mr. W.P. Chakraborty	ESPC, Noida
Mr. Shaji Gupta	ESPC, Noida
Mr. Anoop Sharma	Apollo International Ltd. Gurgaon, India
Mr. Babu	Voltech Engineers Pvt Ltd.
Mr. J. K. Saini	Transrail Testing Centre, Wardha
Mr. Prasad Kothari	Transrail Testing Centre, Wardha

The tower testing was performed as per approved test data sheet and procedure GT48TDS-1 (Rev-A) Dtd: 19.02.2020 at 'Transrail Testing Center' Wardha, on a prototype tower type "DCS" BTB +9m B.E. +3m L.E Tower tested in line with IS:802 Part III. The horizontal & vertical assembly of test prototype was inspected and the tower was erected on the test bed according to the structural drawings as specified in test data & rigging arrangement.

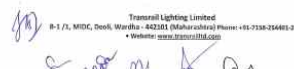
 Transrail Lighting Limited
 B-1/7A, MIDC, Deoli, Wardha - 431203 (Maharashtra) Phone: +91-7338-234480-2
 Website: www.transrail.com

Page 3 of 3



Our Major Projects

Project ID	Project	Scope	Client	End Client	Year of Execution		
INTERNATIONAL - TRANSMISSION LINE							
INTERNATIONAL PROJECTS	DP21069	Dhalkebar Loharpatti 132 kV Transmission Line Project at Nepal 20Km	Civil and Structural	Jakson Group	Nepal Electricity Authority, Nepal	2021	
	DP565	132kV Hydro Power Project Likhu-A,Likhu-1, Likhu-2 Transmission line tower at Nepal -31Km	Civil and Structural	Andriz Hydro	MV Dugar Nepal	2019	
	CIVIL & STRUCTURAL ENGINEERING						
	DP21049	Substations (225kV/30kV at Saint Louis East & Extension of the Existing Substations at tobene, 225Kv)st.Louis ,Tobene,senegal ,West Africa	Civil and Structural	KPTL	National Electricity Co. of Sengal, Africa	2020	
	CP189	132/33kV Mbarara North 2 ,Fort Portal,Nkenda, Opuyo,Tororo&Liya Substation Extension at Uganda	Civil and Structural	HIFAB OY with Sunshine projects Ltd.	Uganda Electricity Transmission Company Ltd.	2013	
	DOMESTIC - CIVIL & STRUCTURAL ENGINEERING						
	DOMESTIC PROJECTS	DP25009	765/400KV KPS-1 _KPS-2_ GIS EXTENSION PROJECT	Civil and Structural	Godrej & Boyce MFG.CO.LTD., India	KHAVDA II-A TRANSMISSION LIMITED	2024
		DP23052	ABL-150MW SOLAR PV PROJECT IN RAJASTHAN	Civil and Structural	Ashoka Buildcon Ltd India	NTPC	2023
		DP24084	220KV GIS SUBSTATION AT INOX MERAMANDALI	Civil and Structural	TOSHIBA Transmission & Distribution Systems (India) Pvt.Ltd	Inox Air Products PVT.Ltd	2023
		DP24091	2Nosx70MWp 50MW solar Yadgir	Civil and Structural	ENERPARC Energy Pvt Ltd, India	Bagmane Developers Pvt Ltd	2023
DP22030		2x100 MW Substation in Cheyagoan and Nagaon-2	Civil and Structural	Siemens Energy	Assam Electricity Grid Corporation Limited	2022	
DP22100		AEGCL Package-D- GIS-Khumtai-Assam	Civil and Structural	RS Infra	Assam Electricity Grid Corporation Limited	2022	
DP22011		Construction of a bulk supply point (bsp) at elubo with 33Kv interconnecting circuits at Ghana-167Km.	Civil and Structural	Alpha TND limited	Electricity Co. of Ghana Ltd.,Africa	2021	
CP452		Structure Designing of 17 Substation in JUSNL Package-1 & Package-2 at Jharkahnad	Civil and Structural	Siemens Energy	Jharkahnad Urja Sancharan Nigam Ltd.	2018	
CP350		220kV AIS Bay Extension & 132kV GIS Substation 60MVA 220/132kV Power Transformer at West Bengal	Civil and Structural	India Power Corporation Limited	Gupta Power Infrastructure Ltd Bhubaneswar, Odisha	2017	
CP242		(i) 400/220kV Samba S/S (ii) 400/220kV Jallandhar S/S (iii) 400/220kV Panchkula S/S	Civil and Structural	TOSHIBA Transmission & Distribution Systems (India) Pvt.Ltd	Power Grid Corporation of India Limited	2015	
CP365	Construction of (2x160+2x50)MVA , 220/132/33kV Grid Substation Sonenagar(New) with SAS& 02Nos. 132kV Bays Extension at Remote End at Sonenagar,Bihar.	Civil and Structural	Techno Electric& Engineering Co. Ltd	Bihar State Power Transmission Co. Ltd	2014		

* For detailed Project list, Kindly Contact Us

Renewables

Voltech offers complete consultancy services from concept to commissioning of solar and wind projects. On solar side, we provide services for roof top solar. Ground mounted solar plants and Floating Solar from kW range to MW range, involving end to end engineering services. Our expertise's covers optimum design of PV modules/arrays. Inverter control room, master control rooms, pooling substation and the transmission lines. One wind side, we provide engineering services for unit substation, power collector system, pooling substation and the transmission lines.

DETAILED ENGINEERING SERVICE

Solar PV & Wind

ELECTRICAL

- Solar AC/DC design
- Inverter control room (ICR) design
- Master control room (MCR) design
- Pooling substation design
- Grid integration studies
- Unit substations
- 33kV power collector system

CIVIL & STRUCTURAL

- Module mounting structure (MMS) design
- IDT foundation
- Inverter control room (ICR) design
- Master control room (MCR) design
- Pooling substation design
- Transmission line design
- Plant roads & drains

OWNER'S ENGINEER SERVICE

Solar AC/DC Engineering

- Solar shading analysis
- Power generation calculations
- Array & string layouts
- AC/DC SLD development
- Plot plan development
- Grid connectivity studies

Pooling Substation/ Transmission Line

Preparation of technical specification for EPC bidding

- Technical bid reviews
- Commercial bid reviews

Review/Approval Engineering

- Electrical & Civil drawings, documents review & approval
- Equipment vendor drawings review and approval
- QAP/TTR review and approval
- Inspection services.



Our Major Projects

Project ID	Project	Scope	Client	End Client	Year of Execution
Solar					
DP 25017	220/33kV, 300MW Solar PV Power Project , Nokha Dahiya, Rajasthan	Owners Engineers service for Pooling Substation	ACME SOLAR HOLDINGS PVT. LTD	ACME SIKAR SOLAR, PVT. LTD	2024
DP 24118	400kV AIS SS for 500MW Solar Badi Sid, Rajasthan	Insulation co-ordination Study	Hitachi Energy India Limited	Adani Renewable Energy Holding Four Limited	2024
DP 24114	220kV, 500MW Solar Project , Fatehgarh, Bhimsar, Rajasthan	Insulation co-ordination Study	Hitachi Energy India Limited	Adani Renewable Energy Holding Four Limited	2024
DP 24112	Pooling SS 400/33kV, 1200MW (PSS-I, PHASE-I & PHASE-II OF 600 MW Each) OF Solar/Wind / Hybrid RE Park of 2375MW Capacity at Great Rann Of Kutch Area, Gujarat	Power & Control Cable Schedule	KEC International Limited	Gujarat Industries Power Co. Ltd	2024
DP 24091	1 No. x 70MWp/50MW, 1No. X 33/110kV Pooling SS and 110kV Grid SS at yadgir, karnataka	Substation Engineering for Electrical & Civil	Enerparc Energy Private Limited	Enerparc Energy Pvt. Ltd.	2024
DP 24077	20 MW Ground Mounted Solar Project at DPL in West Bengal	Civil and Structural Design services	Godrej & Boyce Mfg Co Ltd	The Durgapur Projects Limited	2024
DP 24023	150MW Solar PV Project in Rajasthan	Civil and Structural Design services	Ashoka Buildcon Limited	NTPC Renewable Energy Limited	2024
DP 23104	33kV, 10MW Solar PV Power Plant At Makoth And Koidu , Sierra Leone, Africa	Power & Control Cable Schedule	Kalpataru Power Transmission Limited	Planet Solar Energy Limited	2023
DP 23086	400/33kV, 1000MW Sjn Solar Power Plant - Rajasthan	Power & Control Cable Schedule	GE T&D INDIA LTD	Tata Power Solar Systems Ltd	2023
Wind					
DP 24031	110/33kV PSS First energy & 110/33kV Forth Partner Ottapidaram Project	Relay setting calculation & Co-ordination	Ever Renew Energy Private Limited	Fourth Partner Energy Limited	2023
DP 22014	2x150MVA Wind Farm Plant Project at Location-B Tuticorin	Illumination, Cable schedule & Insulation co-ordination	Hitachi Energy India Limited	JSW Renew Energy Private Limited	2021
DP22009	2x210MVA & 1x160MVA Wind Farm Plant Project at Location-A Tuticorin	Illumination, Cable schedule & Insulation co-ordination	Hitachi Energy India Limited	JSW Renew Energy Private Limited	2021
DP 21040	300MW Windfarm Project at Bhuj, Gujarat – 220/33kV Switchyard	Substation Engineering for Electrical	Siemens Limited	Netra Wind Private Limited	2021
DP 21024	Power Evacuation Scheme for 23.10MW – Telagi, Karnataka	Relay setting calculation & Co-ordination	Bellary Wind Power Private Limited	Bellary Wind Power Pvt. Ltd.	2021
Hybrid					
DP 24108	220/33kV, 160MW Hybrid project at Gudadur, Karnataka	Relay setting calculation & Co-ordination	Vena Energy Vidyuth Private Ltd	Vena Energy Vidyuth Pvt. Ltd.	2024
DP 24092	975MW Hybrid Project Kurnool, Andhra Pradesh	Relay setting calculation & Co-ordination	Toshiba Transmission & Distribution Systems (India) Pvt. Ltd.	A M Green Energy Private Limited	2023

* For detailed Project list, Kindly Contact Us

200+
Projects

Power System Studies

Data Collection | Detailed Studies | Mitigations

INDUSTRIAL POWER SYSTEM STUDIES

- Load Flow Solutions
- Short Circuit Analysis
- Transient Stability Analysis
- Protection Co-ordination and Relay Settings
- Motor Acceleration Study
- Harmonic Study
- Arc Flash Study
- Fast Bus transfer Study
- Transformer energization Study
- Power Quality Analysis
- Earthing & Lighting Protection Study

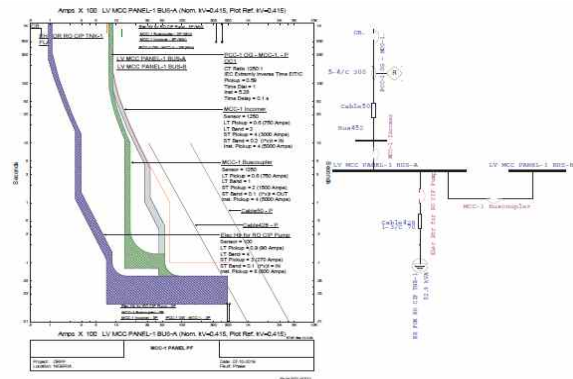

Relay Co-ordination Study

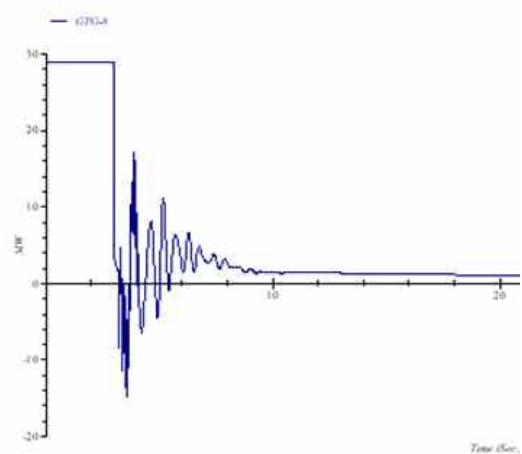

Transient study

UTILITY POWER SYSTEM STUDIES

- Insulation Co-ordination Study
- Protection Coordination and Unit Protection
- EMI Study
- Earthing & Lighting Protection Studies

OUR POWER SYSTEM EXPERIENCE

- Relay coordination Study - 500+
- Load flow and Short Circuit Analysis - 200+
- Motor Starting Study - 100+
- Harmonic Analysis - 20+
- Insulation Coordination Study - 20+
- Transient Stability Analysis - 5+
- Load shedding - 1
- Arc flash study - 20+

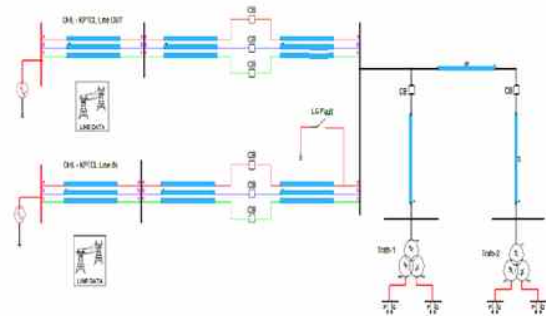

Figure 5: Network diagram for TOV analysis

TOV Analysis



Arc Flash study

Our Major Projects

Project ID	Project	Scope	Client	End Client	Year of Execution	
INTERNATIONAL – OIL AND GAS						
INTERNATIONAL PROJECTS	DP25027	The RLTO Expansion and off-plot facilities of the North field south(NFS) CLLNG Storage & Loading Balance of Plant (BOP) project in Ras Laffan,Qatar	Load flow Study, Short Circuit Study, Relay Setting Calculation & Coordination, Motor Starting Study, Harmonics Analysis, Arc Flash Study	Tecnicas Reunidas, Spain	Qatar Energy LNG, Qatar	2024
	MINES					
	DP25014	6/0.4kV Shalkiya Zinc Project , Kazakhstan	Load flow Study, Short Circuit Study, Relay Setting Calculation & Coordination	FLSmidth Pvt Ltd, India	Shalkiya Zinc Ltd, Kazakhstan	2024
	CEMENT PLANT					
	DP24019	JSW, Fujairah UAE (Clinkerization + WHRS)	Load flow Study, Short Circuit Study, Relay Setting Calculation & Coordination, Harmonics Analysis	ABB India Ltd	JSW Cement, Fujairah, UAE	2023
	WATER TREATMENT PLANT					
	DP23065	50MLD DESALINATION PLANT , SENEGAL (Desalination & Intake Plant)	Load flow Study, Short Circuit Study, Relay Setting Calculation & Coordination	VA TECH WABAG Limited, India	Sones/Eiffage, Senegal	2021
	DOMESTIC – HYDRO POWER PLANT					
	DP25025	500 MW CHITRAVATHI PUMPED STORAGE PROJECT , Andhra Pradesh	Insulation Co-Ordination Study	Andritz Hydro Pvt.Ltd, India	JSW ENERGY (KUTEHR) Ltd, India	2024
	STEEL PLANT					
DP24106	90MW CPP, SHYAM METALICS at Jamuria,West Bengal	Load flow Study, Short Circuit Study, Relay Setting Calculation & Coordination	Shyam Sel & Power Ltd, India	Shyam Sel & Power Ltd, India	2023	
CEMENT PLANT						
DP24020	2.0MTPA Grinding Unit at JSW Vijayanagar	Load flow Study, Short Circuit Study, Relay Setting Calculation & Coordination, Harmonics Analysis	ABB India Ltd, India	JSW Cement, Vijayanagar, India	2023	
WATER TREATMENT PLANT						
CP 503	RODM, RWTP and ETP packages in Polymer addition project, Punjab	Load flow Study, Short Circuit Study, Relay Setting Calculation & Coordination & Motor Starting Study	Va Tech Wabag Limited	HPCL Mittal Energy	2020	
POWER PLANT						
DP24063	NTPC-11/3.3/0.415kV Project Site survey, Retrofit drawing , Sipat	Site survey and Relay Setting Calculation & Coordination	Siemens Ltd	NTPC, Sipat	2023	
DATA CENTRE						
DP21050	MAA20 Chennai DC3 Project at Ambattur, Chennai	Relay Setting Calculation & Coordination	ST Telemedia(STT), India	ST Telemedia (STT), India	2021	

* For detailed Project list, Kindly Contact Us

Industrial Plant Engineering

Pre-Bid Engineering | Basic Engineering | Detailed Engineering

ELECTRICAL

- Load List and SLD development
- Load Flow, Short circuit, Transient Stability Studies
- Switchgear & Equipment Layouts
- Transformer & Switchgear Sizing
- Cabling System Engineering
- Earthing & Lightning Protection
- Illumination Design
- Protection Co-ordination and Settings
- Procurement Support
- Equipment Inspection (FAT) Support



INSTRUMENTATION

- P&ID Review - Instrument List
- Hook Up Diagram
- Cable Engineering
- Earthing Engineering
- Procurement Support
- Installation Support



Our Major Projects

INDUSTRIAL PLANT

Project ID	Project	Scope	Client	End Client	Year of Execution
INTERNATIONAL - Water Treatment Plants (Industrial Waste Water Treatment Plant & Desalination)					
DP25011	Industrial Waste Water Treatment Plant at RAS TANURA, Saudi Arabia	Detail Engineering & System Studies	VATech Wabag Limited, India	Saudi Aramco, Saudi Arabia	2024
DP23065	50 MLD RO Desalination Plant at Senegal, Africa	Detail Engineering & System Studies	VATech Wabag Limited, India	Nippon Koei, Japan	2023
CASHEW INDUSTRIAL PLANT					
DP25003	Valency International Ivory Coast-Cashew Plant , Cate D'Ivoire, Africa	Detail Engineering & System Studies	Valency International Tradition SARL, Côte d'Ivoire, Africa	Valency International Tradition SARL, Côte d'Ivoire, Africa	2024
DP23070	Afcot Cashew Sarlu.at yamoussoukro , Cate D'Ivoire, Africa	Detail Engineering & System Studies	Afcot Cashew Plant, Côte d'Ivoire, Africa	Afcot Cashew Plant, Côte d'Ivoire, Africa	2023
HYDRO ELECTRIC PLANT					
DP24028	Namsam 3 HEP (3 X 52 MW) at Vietnam	Illumination Engineering	Voith Hydro Private Limited, India	Namsam 3 power co. Ltd, Vietnam	2023
DOMESTIC - AIR SEPERATION PLANTS					
DP24070	170 TPD Air Seperation Unit at Tata Metaliks, Kharagpur, India	Detail Engineering & System Studies	Ellenbarrie Industrial Gases Limited, India	Tata Metaliks Limited, India	2023
DP24122	220 TPD Air Seperation Unit , Ulluberia, India	Detail Engineering & System Studies	Ellenbarrie Industrial Gases Limited, India	Ellenbarrie Industrial Gases Limited, India	2023
WATER TREATMENT PLANTS (DESALINATION)					
DP485	30MLD SWRO Desalination Plant for MRPL Refinery, Mangalore, Karnataka	Detail Engineering & System Studies	VATech Wabag Limited, India	Mangalore Refinery and petchems Ltd, Karnataka, India	2021
CEMENT PLANT					
DP22058	3000TPD, Limestone Benefication Plant , Ramco Cements , RR Nagar, India	Detail Engineering	FLSmith Private Limited, India	Ramco Cements Limited, India	2021
DP22046	Sonar bangla Cement Grinding Unit , West Bengal, India	Detail Engineering	ABB India Limited, India	Ultratech Cement Ltd, India	2021
HYDRO ELECTRIC PLANT					
DP24107	Khandong Power Station (2x23 MW) at Assam,India	Illumination Engineering	Voith Hydro Private Limited, India	North Eastern Electric Power Corp. Ltd, India	2023
Green Hydrogen Plant					
DP24076	4.3TPD Green Hydrogen Plant at GAIL Complex, Vijaipur, Maharashtra	Detail Engineering & System Studies	Godrej & Boyce Manufacturing Co. Ltd,India	Gas Authority of India Ltd, India	2023

* For detailed Project list, Kindly Contact Us

Major PO

SIEMENS

Purchase order
Amendment 1 / 30.05.2024

Siemens Limited Registered Office: Britia Avenue, Level 21, Plot No. 1005-D, Arco Board
Floor 21, Marine Drive, Chennai 600055. Corporate Identity Number: U70200TN1907473703
PAN: AAACV0108M GSTIN: 33AACCV0108M1ZK E-mail: siemens.in@siemens.com

Voltech Engineers Pvt. Ltd.
No. 2/429, Mount Poonamalle Rd.,
Voltech Eco Tower, Ayyappanthangal
600055 Chennai
India
STATE CODE: 33
State Name: Tamil Nadu

GSTIN: 33AACCV0108M1ZK
PAN: AACCV0108M

Attn: M UMATHI.
PHONE: +91 +91-44-43978000

Please deliver to
Siemens Ltd.
301, 3rd floor,
Prerna Arbour, Navarangpura
Ahmedabad - 380009
India, POS: 24

This Purchase Order ("PO") is subject to the signed terms and conditions. All goods or services shall be delivered in accordance with the order to comply with international export regulations, whereever applicable, every invoice shall state related ECEN or AL number for the goods or product(s) supplied.

Order No: 451284377	Date: 24.05.2024	Your Vendor No. with us: 50050554	Your reference:	Directors Interest:
References:	Our Org-Id: A1202696	GBK:	Contact: RAJEEV KUMAR, IN GBS ASP P2P IN SC 1 2 Phone +91 11206445 E-mail rajeevkumar.ext@siemens.com	
Invoice Address: Siemens Ltd. 301, 3rd floor, Ahmedabad - 380009	Incoterms: DAP DAP 2010(Delivery at Place)	Mode of Dispatch: Recipient: Part delivery: Delivery date:	DAP DAP 2010(Delivery at Place) Parist delivery allowed 24 May 2024	
Bill To GSTIN: 24AAAC50764L1ZC Place of Supply: 24	Payment Terms: 45 days after GRN date only for Non-MicroSmall	In case of any GST related non-compliance by the supplier (whether under this PO or any other contract), Siemens shall have the right to withhold / adjust the GST amount payable under any invoice (s) under this Agreement or any other agreement with the Supplier till such non-compliance is rectified by the Supplier to the satisfaction of Siemens.		
Remarks:	Project: 220KV GIS (AMRS) Hazira.			

ENERPARC

Enerparc Energy Private Limited
Unit No 401, 4th Floor, Eastern Wing, HM Towers, No 58, Brigade Road, Bengaluru-560001 India

Doc No: EEP/SCMP/RS No:170

PURCHASE ORDER

Ms. Supplier details
Voltech Engineers Pvt Ltd
Voltech Eco Tower No. 2/429, Mount Poonamalle Road
Ayyappanthangal,
Chennai Tamil Nadu-600055 India

Our Reference
Purchase Order No: EEP/2023-24SC/10149
Purchase Order Date: 20/12/2023
Revision No:
Revision Date:
GSTIN No: 33AACCV0108M1ZK
TAX No: GSTIN No: 33AACCV0108M1ZK
PAN No: AADCE933007
Contact Person: M Anjanan Rajakumar
Project Code: EP2023-24-13
Contract No:
Contract Name: Open Access ESP4
Email: net

S.No	HSN/SAC	Description of Material	UOM	Quantity	Unit Rate	Basic Amount	Tax Rate(%)	Tax Amount	Sub Total
1	009833	Consultancy and Detail Engineering work / 2311KV PIS, 110 KV Bay GIS and 110KV Transmission line detail Engineering and product approval as per Agreed SOW	Lot	1					
SUB TOTAL (INR)									
Freight, Packing & forwarding:									0.00
TOTAL PO/OW PRICE:									
Amount in Words (INR):									

Delivery Schedule: As mutually agreed schedule

Warranty:

Confidentiality Clause: Confidential information shall not be disclosed to third parties without the prior written consent of Enerparc, provided that the Contractor may grant access to the Confidential information to their respective affiliates, and to their respective employees, banks and vendors, legal counsel, chartered accountants, library of law and Renewable Energy/and of India, and authorized contractors, subcontractors, vendors, representatives and agents subject to such access is necessary to fulfill the terms of this Contract or in connection with the PV Power Plant and subject that they are bound by confidentiality arrangements.

TECNICAS REUNIDAS

Work Order

Supplier code: 102346
Name: VOLTECH ENGINEERS PVT LTD VOLTECH ENGINEERS PVT LTD
Address: Poonamalle Road, Ayyappanthangal, Chennai Voltech Eco Tower, No. 2/429, Mount, Tamil Nadu-600055 India

Ship To:
ACME Solar Holdings Pvt Ltd.
Khanza No. 13, Rakhs 94, Village, Yodha, Tehsil, Gujarat;
Bikaner Rajasthan 334001
Contact No:

PO Type: Services Domestic
Reference:
Pay Term:

S.No	Item Code	Description	PCode	HSN	UOM	Qty	Rate	Value	Tax code	SGST/IGST	CGST	IGST	Tax Amount	Currency	Delivery Date
1	9000003409	Review of Design Engineering	G066	999333											
Base Value															
TGST															
Total PO Value															

Amount in Words: Rupee (D/R)

1. Please ensure to include the correct Purchase Order number, complete Delivery Address and ACME Item Code on your D/V INVOICES and ship with standard Packing List with serial no. of all components and inspection report of material and Material Dispatch Clearance Certificate (MDC) issued by ACME.

Header Text: Review of Design Engineering for 220KV Switchyard Package for 300MW MSEDCL 6 Bikaner Project.
price is exclusive of any visit cost & all visit cost shall be paid as per mutually agreed price in future.

Terms of Payment: 80% of lump sum fee shall be paid on submission of Drawings/Documents on pro-rata basis as per the Billing Break-up schedule which will be mutually discussed & agreed in kick-off meeting.
15% of PO value shall be claimed up on documents for Final review/approval.

SELLER: V00000690 - VOLTECH ENGINE PVT LIMITED
2/429 VOLTECH ECO TOWER
MOUNT POONAMALLE HIGH ROAD,
AYYAPPANTHANGAL
600055 CHENNAI
TAMIL NADU
INDIA

PROJECT: BOP QATAR
PROJECT No.: 10620
PURCHASE ORDER FOR: ELECTRICAL STUDIES VALIDATIONS

This PURCHASE ORDER is issued for the SUPPLY and/or SERVICES as detailed herein and in the rest of documents of the ORDER. The ORDER comprises the sets of documents listed as follows and sets out the entire agreement between the PARTIES with respect to the subject of this PURCHASE ORDER and supersedes any verbal or written agreement signed prior to the COMMENCEMENT DATE unless otherwise indicated in the ORDER.

A - The present PURCHASE ORDER
B - The Deviation List: DL-106202306-V00000690_REV_01_20240711
D - 10370 OFF General Subcontracting Conditions for Studies Rev 05
E - Requisition for Purchase 106202306/V00000690 suppl G date 08-JUL-24

PURCHASE ORDER amount up to Supplement 00: EUR
PURCHASE ORDER Supplement amount: EUR
Current total PURCHASE ORDER amount: EUR
Current total PURCHASE ORDER in words:

The breakdown of the total PURCHASE ORDER value is shown on Section "SUPPLEMENT BREAKDOWN".
Commercial terms (INCOTERMS): NA
Delivery place: NA

The original copy of the first page of this PURCHASE ORDER shall be signed and stamped by a SELLER's duly authorized representative and shall be returned to BUYER within ten (10) days. SELLER, by signature of this PURCHASE ORDER, accepts without reservation all the provisions set out in the ORDER.

Acceptance by the SELLER
Signature: [Signature]
Full Name: [Name]
Title: [Title]
SELLER'S Reference: [Reference]

For and on behalf of BUYER
Signature: [Signature]
Full Name: Pablo Andres Saenz
Title: Regional Director
SELLER'S Reference: Maria Dolores Serrano

Purchase Order Number: 1062023080 Suppl: 00 Page: 1 of 6

PO Number: 1099170004
Contact Name: G KRISHNAMOORTHY
Email: voltech@voltechgroup.com

Our Location State: Maharashtra
WE ARE PLEASED TO PLACE AN ORDER ON YOU AS PER DETAILS GIVEN & TERMS & CONDITIONS SPECIFIED BELOW

Header Text: Civil and Structural Design services 20 MW Ground Mounted Solar Project at DPL in West Bengal project.
Scope will be same as shared by engineering team.

Payment terms:
• 80% Payment to be made upon final submission of documents.
• 20% shall be paid upon approval of documents/drawings.
• The payment shall be made within 30 days from the date of invoice submission.

No	Item Code	Item Details	Project	Schedule Details
10	PSBEF22	Civil Design & Engineer services	SBP19074	Schedule Quantity: 1.0000 Purchase Unit: EA Delivery Date: 31-10-2023

Price Structure:
Basic Price
Subcontracting Price
Price Unit
Line Discount
ASV Per Unit for GST
IGST 15%
Sub Total 1
Total Cost (GST)
Total Amount
Currency

PO Line Text: This PO is created for Balance work of Design/Civil consultancy services. It is part of PO No: 50309474

GENERAL TERMS AND CONDITIONS OF PURCHASE

This Purchase Order constitutes Goelty & Blyock Mfg. Co. Ltd.'s ("Purchaser") offer to purchase from Supplier those materials, products and equipment ("Products"), as well as those services ("Services"), set forth in this Purchase Order. "Supplier" shall mean the entity set out in the Purchase Order supplying the Products/Services.

This Purchase Order also includes all Deliverables. "Deliverables" means all items in tangible and intangible form, including inventions, discoveries, works of authorship, programs, derivative works, source code, object code, ideas, techniques, methods, processes, information, data, documentation and materials, that Supplier and/or its employees, agents create, prepare or deliver, or otherwise produce, conceive, make, propose or develop as a result of this Purchase Order as the result of rendering the Services.

Any Special Conditions mentioned on the Purchase Order shall be read in conjunction with these General Terms and Conditions and all other documents forming part of this Purchase Order. In case of any inconsistency between the contract documents, the following order of priority will apply:
(i) Any definitive agreement between the parties covering the Products and Services (if such an agreement exists),
(ii) Special Conditions, under this Purchase Order, and
(iii) These General Terms and Conditions.

The Supplier shall be deemed to have carefully examined all the documents, including this Purchase Order to its entire satisfaction. Products and Services supplied against this Purchase Order shall strictly adhere to the Purchaser's approved specifications.

Performance Certificates



Siemens Limited, RC-IN SE GP T SO OPS PE ER, 43, Shanti Park, Raahibhat, Bypass Connector, Kolkata 700042, India

To, Mr. Sankar T. DGM, Engineering Consultancy Service, VOLTECH ENGINEERS PVT. LTD, INDIA

Name: Chiranjib Sarker
Department: RC-IN SE GP T SO OPS PE ER
Telephone: +91 (33) 30939456
Mobile: +91 9088102314
E-mail: chiranjib.sarker@siemens.com

Your letter of Our reference Date: 4508674177, dated on: 31st Oct 2018.
Email dated: 18.01.2021, dated on: 31st Oct 2018, January 18, 2021

Work Completion Certificate.

PO Details :- 4508674177, dated on: 31st Oct 2018.

Name of Work :- Site Survey, Design, Engineering, for removal of deficiency and up-gradation of protection system for JUSNL transmission system in Jharkhand state under PSDF scheme.

Name of Contractor :- VOLTECH ENGINEERS PVT. LTD.

As per PO General Terms & Conditions relating to the Survey, Design, Engineering for up-gradation of protection system for JUSNL transmission system in Jharkhand state under PSDF scheme of 17x 132/33 KV Grid Sub-Station, we hereby informed you that the Scope of Work were satisfactorily attained as specified below.

Site Visit:

- Visit to various sites of JUSNL under pkg-1 & 2 and checking the physical condition and dimension of the existing relay and control panel. Collection of data from field.
- Outdoor Testing support during live panel checking with required tools during site survey.

Engineering for Panel Augmentation:

- According to the actual data of various sites, drawings have to be prepared for relay retrofitting.
- Submission of drawings to the customer for approval, incorporation of customer comments, discussion and resubmits for final approval.
- Preparation of detailed BOQ, wiring schedule and cable schedule based on final approval of drawings.
- For new panel cable routing and schedule must be prepared and get it approved from customer.
- Cable Schedule with Manufacturing Drum Schedule.

Siemens Limited Management: Sunil Mathur 43, Shanti Park, Raahibhat, Bypass Connector Kolkata 700042 India Tel: +91 (33) 2444 9000

Registered Office: Billa Aurora, Level 21, Plot No. 1080, Di. Arnie Basant Road, Work. Mumbai - 400020, Corporate Identity number: L28020M-1957PLC010020. Tel: +91 (22) 3987 7000. Fax: +91 22 2436 2436. Contact Email: www.siemens.co.in/contact. Website: www.siemens.co.in

Sales Office: Kolkata, Bengaluru, Bhopal, Bhubaneswar, Chandigarh, Chennai, Coimbatore, Gurgaon, Hyderabad, Jaipur, Jamshedpur, Raigarh, Kolkata, Lucknow, Kochi, Mumbai, Nagpur, Navi Mumbai, New Delhi, Pune, Vadodra, Visakhapatnam, Hyderabad, Jaipur, Jamshedpur, Raigarh, Kolkata, SCF 062020 V20.10

Siemens Energy is a registered trademark licensed by Siemens AG. Page 1 of 2



NCC Limited
Project: Airport - Agartala

06th Dec 2021

TO WHOM SOEVER IT MAY CONCERN

Project : Engineering Consultancy work for HT Relay Setting calculation & coordination for Proposed NITB Project at Agartala Airport, Tripura.

Customer : Airport Authority of India, Agartala, Tripura.

PO No : NCCL/AAI-AGT/HIRE/WO/043/2021-22, Dt on: 11th Oct 2021.

This is to certify **M/s. Voltech Engineers Private Limited** have Completed the Proposed NITB Project at Agartala, Tripura for the following activities successfully.

- Relay Setting Calculation and Co-ordination

Their Performance in this project with respect to preparation of documents and drawing for submission/approval was as satisfactory.

Mohamed Sabeek B
Junior Engineer - Electrical
NCC Limited
Airport - Agartala Project.

NCC Limited
(Formerly Nagarjuna Construction Co. Ltd)
C/o Civil Engineers Enterprises Pvt. Ltd., New Hospital Project, Near Sabji Mandi Housing, Lower Sichey, ocheygaon Gangtok, Sikkim - 737101. Email ID : bldgs.sahgangtok@ncccltd.in

ISO Certification



Bureau Veritas Certification

VOLTECH ENGINEERS PVT. LTD.



VOLTECH ECO TOWER, NO: 2/429, MOUNT POONAMALLEE ROAD, AYYAPPANTHANGAL, CHENNAI - 600 056, TAMIL NADU, INDIA.

Bureau Veritas Certification Holding SAS - UK Branch certifies that the Management System of the above organisation has been audited and found to be in accordance with the requirements of the Management System Standard detailed below.

Standard

ISO 9001:2015

Scope of certification

DESIGN AND ENGINEERING OF ELECTRICAL, INSTRUMENTATION, CIVIL & STRUCTURAL PROJECTS FOR POWER GENERATION, TRANSMISSION & DISTRIBUTION SECTORS

Original cycle start date: **10 February 2020**
Expiry date of previous cycle: **09 February 2023**
Recertification Audit date: **11 January 2023**
Recertification cycle start date: **06 March 2023**

Subject to the continued satisfactory operation of the organisation's Management System, this certificate is valid until: **09 February 2026**

Certificate No. **IND.23.4052/QM/U** Version: 1 Issue date: **06 March 2023**

For certificate authenticity, click here <https://certcheck.ukas.com>

Signed on behalf of BVCH SAS UK Branch
Jagdish N. MANJAV
Director - CERTIFICATION, South Asia
Commodities, Industry & Facilities Division

Certification body address: 5th Floor, 66 Penton Street, London, E1 9HQ, United Kingdom.

Local office: Bureau Veritas (India) Private Limited (Certification Business)
72 Business Park, Marol Industrial Area, MIDC Cross Road 'C',
Andheri (East), Mumbai - 400 083, India

Further clarifications regarding the scope of this certificate and the applicability of the management system requirements may be obtained by consulting the organisation.
To check this certificate validity please call +91 22 6274 2000.



Voltech Engineers Pvt Ltd
(ICE - Design & Engineering Division)

Quality Policy

We, Voltech Engineers Pvt. Ltd. - ICE, are committed to provide quality design and engineering services to our customers in the field of Electrical Power Generation, Transmission and Distribution, with the prime goal of Customer Satisfaction at all times.

We strive to actively engage the employees across the Organisation and provide necessary resources to offer Quality Services to our customers.

VEPL - ICE is committed to continually improving the effectiveness of the Quality Management System (QMS) through periodic review and by adopting innovative new practices.

VEPL - ICE shall be continuously upgrading the capabilities of its technical and administrative staff through formal training and continuous technical and quality awareness programs.

This Quality Policy shall form part of our Quality Management System.

VEPL-ICE-QP-R0
01-08-2019

M. Umopathi
Managing Director

Voltech Eco Tower, 2/429, Mount Poonamallee Road, Ayyappanthangal, Chennai - 600 056
PH: + (91) - 44 - 4397 8000 Extn: 290 Fax: + (91) - 44 - 42867746
www.voltechgroup.com

Leadership Team



S. Angelson Rajeshkumar

Vice President & Business Head of Engineering

angelson@voltechgroup.com

+91 94443 99037

Angelson Rajeshkumar, is an electrical engineer by profession with 30 years of design experience in designing substations, transmission lines and other industrial power systems. He worked in Larsen & Toubro limited, India for more than 21 years and short stint in ABB, India, before joining Voltech as Design Business head. He has vast experience in designing substations up to 765kV for various Indian utilities & ASEAN utilities and Nuclear Power plants in India. He has presented Technical papers in various forums. His area of interest is Substation Engineering & Renewables.



G. Subramanian

Technical Head - Electrical

subramanian.g@voltechgroup.com

+91 94446 26174

Subramanian G is an Electrical Engineer by Profession having 40+ years of experience in design & engineering of various Thermal power plants, Solar PV plants, Desal plants, Industrial & Commercial Power systems, EHV Substations and Transmission lines. He is conversant with various electrical calculations, Specifications, Schemes, layouts, Electrical power system studies, Protection coordination studies. He has worked with NTPC, Crompton Greaves and Fichtner Consulting Engineers. He is with Voltech Group as a Principal Consultant, guiding Engineers and resolving various technical issues in design & engineering of Power systems.



K. Sankar

Head – Substation Engineering

sankar.k@voltechgroup.com

+91 94430 83861

Sankar K, is an electrical engineer by profession with 25 years of design experience in Substation design and engineering for substations, HVDC station, power plants and Industrial process plants. He worked in GEC Alstom India Ltd., AI-Waha Technologies India Pvt. Ltd and Saad Group of Companies for more than 10 years before joining Voltech as an engineering team lead. He has vast experience in substation engineering, illumination engineering providing best lighting support for projects and providing excellent consultancy to our customers.

Our leadership

is shaping the future of **Engineering services.** >>>>





S. Babukumar

Head – Transmission Line, Civil & Structural

 babukumar.s@voltechgroup.com

 +91 79040 67184

Babukumar is a Civil engineer by profession with 15 years experience in Transmission lines and substation Civil & Structural Engineering, industrial plants. He started his carrier with Voltech in 2014. Presently, he is heading the Transmission line , Civil & Structural Engineering business unit. He worked in simplex infrastructures limited & Powertech engineering pvt. Ltd, before joining Voltech. He has vast experience in Substation Design, Power Plant Design & Detailing. His Area if Interest is Transmission Lines & Industrial Building Design.



D. Anbarasu

Head – Power System Studies

 anbarasu.d@voltechgroup.com

 +91 95000 98378

Anbarasu is an electrical engineer by profession with 15 years of experience joined Voltech in the year 2009. He worked in Testing and commissioning, Control & Relay Panel engineering of substations within Voltech group before taking up Design assignment. Presently, he is heading power system studies business unit. He worked in Schneider Electric (KSA) for a brief period. He has vast experience in Control & Relay panel engineering, Protection systems and power system studies. His area if interest is Protection Engineering & Power system studies.



M. Suresh Babu

Head – Industrial Plant Engineering

 sureshbabu.m@voltechgroup.com

 +91 98942 28081

Sureshbabu is a Bachelor in Electrical & Electronics Engineering and Masters in Power Systems having about 13 years of Design & Engineering experience. He has a sound Knowledge in Industrial Plant Systems namely Power Plants, Cement Plants, Solar Plants, Water treatment plant etc. He is expert in EHV Protection systems and Industrial power system studies



Leadership Team



Parthiban Ranganathan

Head - Renewables

parthiban.r@voltechgroup.com

+91 96299 32413

Parthiban is an electrical engineer by profession with 13 years of experience. He handled secondary engineering of substation for about 4 years and worked in Qatar for above 4 years, before taking up power system studies. He is presently handling insulation co-ordination studies along with power system studies. He is also an expert in Renewable Sector and Specializing in Solar, Wind, Hydro and biomass power plants.



V. Sharanya

Business Management – Asst. Manager

sharanya.v@voltechgroup.com

+91 99406 66315

Sharanya is a Masters in Commerce having about 10 years of experience. She handles the Quality and Training for the Engineering Unit, She is a Certified Human Resource Management from Loyola Institute Of Business Administration (LIBA).

Softwares Used



Drafting

DIALux

Lighting Design



Power System Studies



Drafting

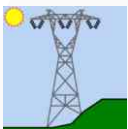

PLS Tower

Transmission Tower Design



Drafting



STAAD Pro - Connection

Structure Design



Transient Studies



Solar Plant Design

CYMGrd 6.3

Earthing Design



Inventor

Mechanical 3D design of Panels



Panel Fabrication Design



Factory Shop floor Management

Our Major Clients

INTERNATIONAL CLIENTS



Spain



Turkey



Baharain



Spain



Dubai



Belgium



Spain



DOMESTIC CLIENTS



and many more...

Our Infrastructure



Corporate Office - Voltech Eco Tower

INFRA HIGH- LIGHTS

5000 Sq.Ft

DESIGN OFFICE FLOOR SPACE

75+

ENGINEERS

100+

WORKSTATIONS

1000+ Books

TECHNICAL LIBRARY



Executive Cabin



Board Room



Employees Workspace



Library



Reception Area



Lobby



Aadukalam (Recreation Room)



Cafeteria

Global Presence

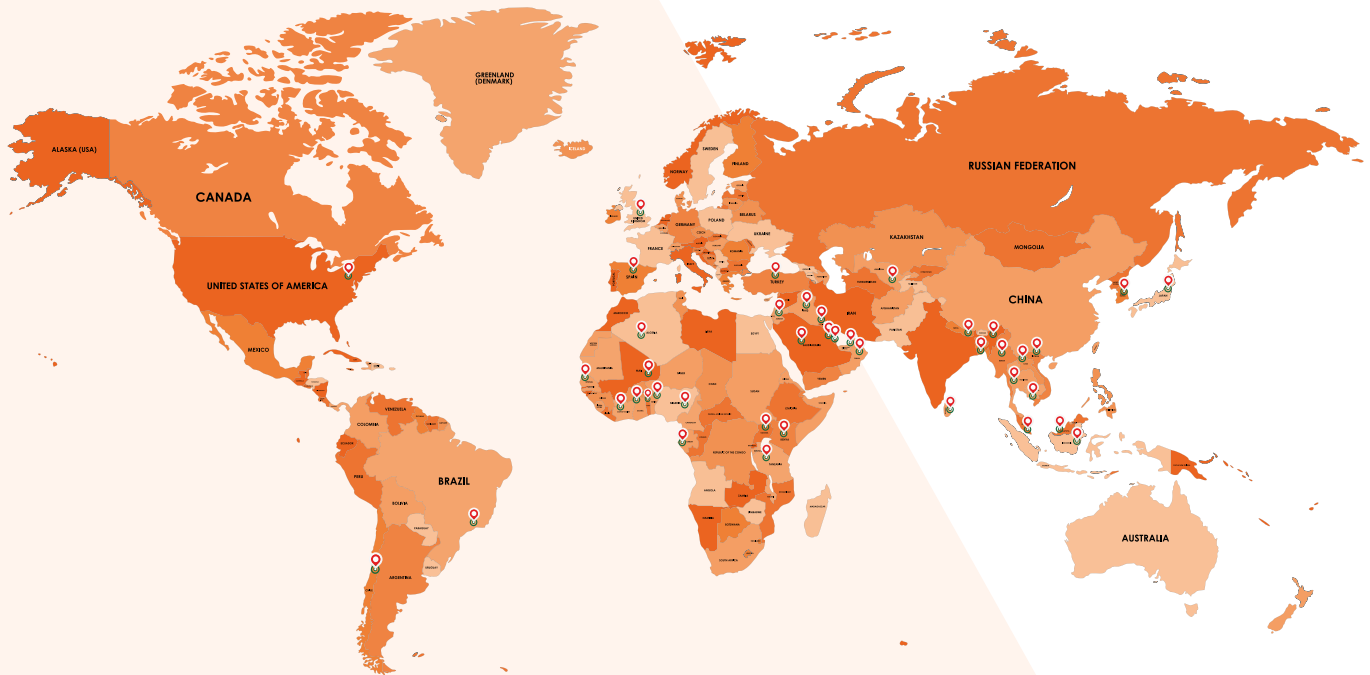

International Locations :

ASEAN : Cambodia | Indonesia | Laos | Myanmar | Malaysia | Singapore | Thailand | Vietnam

SAARC : Bangladesh | Nepal | Sri Lanka

Middle East Countries : Bahrain | Iraq | Jordan | Kuwait | Oman | Qatar
Saudi Arabia | U.A.E

Africa : Algeria | Benin | Cote d'ivoire | Ghana | Gubon | Kenya | Mali
Nigeria | Senegal | Tanzania | Uganda | Togo

Europe : Spain | Turkey | United Kingdom

Americas : USA, Brazil, Chile

CIS Countries : Uzbekistan

Japan | South Korea

Domestic Locations :

Bangalore | Bhubaneswar | Bilaspur | Chennai

Coimbatore | Guwahati | Hyderabad

Kochi | Kolkata | Lucknow | Mumbai | New Delhi

Raipur | Vadodara | Vizag

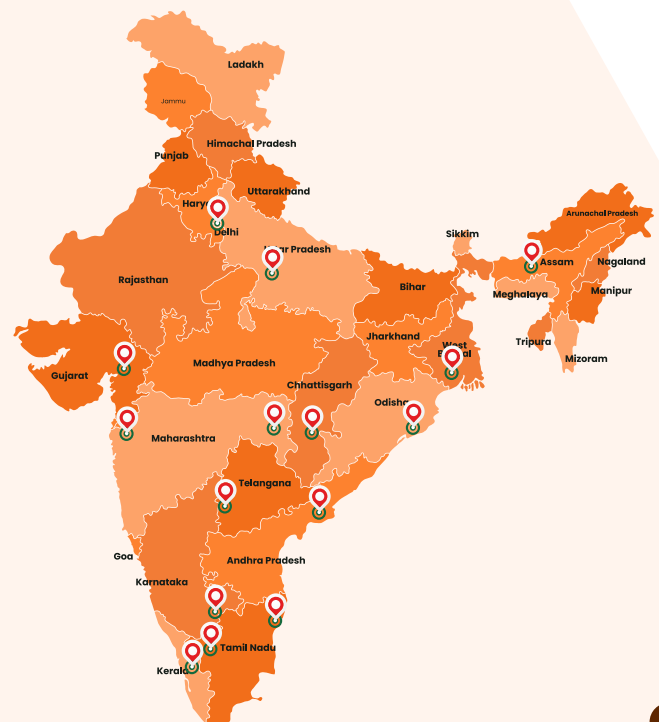

FOR DIGITAL COPY, SCAN HERE



Registered Office :
Voltech Eco Tower,
No. 2/429, Mount Poonamallee Road,
Ayyappanthangal, Chennai – 600 056, Tamil Nadu
Email : engineering@voltechgroup.com
Ph. : 044 4397 8000

VOLTECH[®]
EXCELLENCE IN ENGINEERING PRODUCTS & SERVICES

www.voltechgroup.com

Follow us on

